

Parade Recessed

L-2 MC / L-3 MC

User's Manual

Rev. 09

Date: 19/04/2024



551177



	Parade L MC 2 Recessed	Parade L MC 3 Recessed
Code / Codice	AL5252	AL5257
Power consumption Consumo di energia	37W	55W
Nominal current Corrente nominale	0.17A @230Vac	0.25A @230Vac
Power supply Alimentazione elettrica	220-240VAC 50/60Hz	
Inrush current / Corrente di spunto	27.5A @240VAC, 25°C	27.5 A @240VAC, 25°C
Power factor / Fattore di potenza	cos.φ=0.94	cos.φ=0.95
Electrical class / Classe elettrica	I	
Weight / Peso	6.9 Kg (15,2 Lb)	9.2 Kg (20,3 Lb)
Operating temperature Temperatura di funzionamento	-40°C to +50°C (-40°F to 122°F)	
IP rating / Grado IP	IP67	
IK rating / Grado IK	IK10	

Dimensions - Dimensioni

Parade L MC 2 Recessed

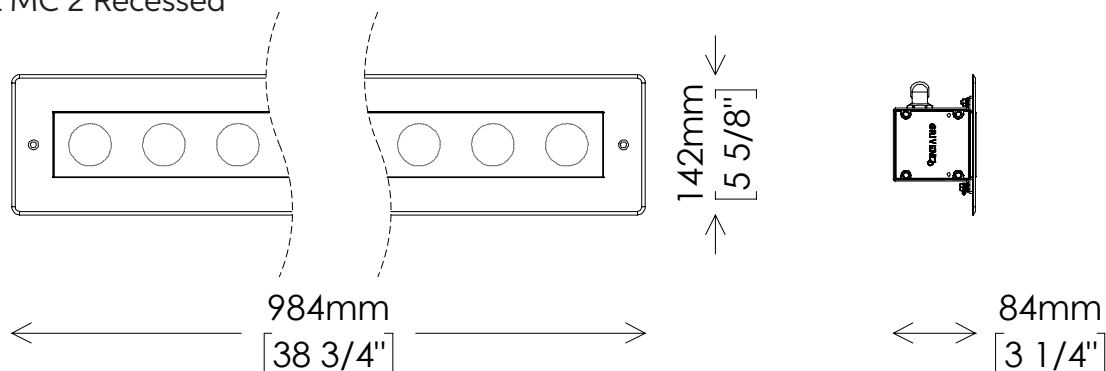

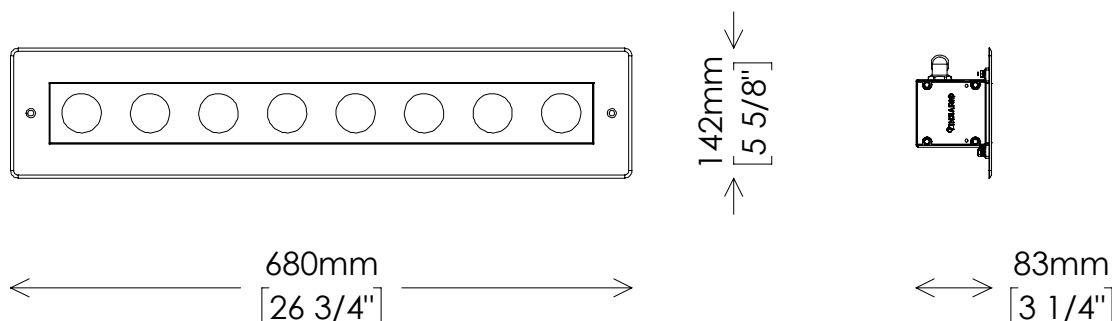

Parade L MC 3 Recessed



Important notices - Avvisi importanti

- This product must be installed in accordance with applicable national and local electrical and construction codes by a person familiar with the construction and operation of the product and the hazards involved. Failure to comply with the following installation instructions may result in death or serious injury.
- Do not stare at the operating light source.
- The fixture might be damaged by excess voltage. The installation of an overvoltage protection device on the electrical system (SPD) is recommended for reduce the risk of damage.
- The use of an adequate magnetothermic switch along the power supply line is recommended.
- Connect the fixtures to each other only when disconnected from mains.
- Never leave cables and connectors unconnected or unprotected for long periods.
- Disconnect power before installing or servicing to avoid electrical shock.
- Disconnect power before any connection operation.
- Check voltage and frequency before powering the fixture. Do not exceed fixture specified voltage.
- Do not handle the unit with wet hands or in wet environments.
- Apply to qualified staff for any maintenance service not described in this instructions manual.
- Do not exceed the maximum quantity of fixtures per line in order to avoid power surges.
- Before powering the unit, ensure to use cables and connectors with proper section and length, according to its power consumption.
- Fix the projector by using screws, hooks or other adequate supports that can bear its weight.
- If the external flexible cable of this appliance is damaged, it must only be replaced by the manufacturer, its assistance service or equivalent qualified personnel in order to avoid hazards.
- Integrated temperature control, the projector reduces power when $T_a > 35^\circ\text{C}$.
- The luminaire should be positioned so that prolonged observation of the luminaire at a distance of less than 2 meters (6.56 ft) is not expected.

- Questo prodotto deve essere installato secondo le normative locali, da personale specializzato. La mancata osservanza delle istruzioni di installazione può portare a situazioni di pericolo all'incolumità della persone.
- Non fissare la sorgente luminosa durante il suo funzionamento.
- Apparecchiatura sensibile alle sovratensioni. Si consiglia l'installazione di un dispositivo di protezione delle sovratensioni (SPD) sull'impianto elettrico per attenuare l'intensità di questi fenomeni proteggendo gli apparecchi dal rischio che vengano danneggiati.
- E' consigliato l'uso di un adeguato interruttore magnetotermico/differenziale sulla linea di alimentazione.
- Collegare tra loro i proiettori solo quando nessuno di essi è collegato alla rete elettrica.
- Non lasciare mai per lungo tempo agli agenti atmosferici cavi e connettori non collegati o non protetti.
- Togliere l'alimentazione prima di effettuare qualsiasi operazione all'interno dell'apparecchiatura.
- Togliere l'alimentazione prima di effettuare qualsiasi operazione di connessione tra gli apparecchi.
- Prima di connettere l'apparecchio alla rete elettrica, verificate la compatibilità di tensione e frequenza.
- Non maneggiate il prodotto con mani bagnate o in presenza di acqua.
- Rivolgersi ad un tecnico qualificato per qualsiasi operazione di manutenzione ordinaria non descritta nel presente manuale.
- Non superare il numero massimo specificato di apparecchi per linea per evitare pericolosi sovraccarichi di corrente.
- Prima di effettuare le connessioni verificare la portata dei cavi / connettori e la lunghezza dei cavi tenendo conto dell'assorbimento del prodotto.
- Fissare il proiettore con viti, ganci o altri supporti in grado di sostenerne il peso.
- Se il cavo flessibile esterno di questo apparecchio viene danneggiato, deve essere sostituito esclusivamente dal produttore, dal suo servizio di assistenza o da personale qualificato equivalente, al fine di evitare pericoli.
- Controllo della temperatura integrato, il proiettore reduce la potenza ad una $T_a > 35^\circ\text{C}$
- l'apparecchio di illuminazione dovrebbe essere posizionato in modo che non sia prevista un'osservazione prolungata dell'apparecchio ad una distanza inferiore a 2 metri.

  **CAUTION: Prolonged staring at the LED source should be avoided by placing the fixture in a proper position.**

  **WARNING ! Fixing and connecting operations must mandatorily be carried out by qualified personnel only !**

  **WARNING ! Make sure that power supply is off before connecting or disconnecting fixtures !**



The possibility of reusing some electrical parts of the device is subject to the total responsibility of the user. The label shows the symbol indicated in Legislative Decree n.49 of 14 March 2014 which transposes Directive 2012/19 / EU, which indicates the need to dispose of the product in separate waste, specifically in electrical waste. and electronic. Refer to the waste collection center located in your area.





Replaceable control gear by a professional



Replaceable (LED only) light source by a professional

  **ATTENZIONE! Fissare la sorgente LED per un periodo prolungato va evitato posizionando l'apparecchio nella posizione appropriata.**

  **ATTENZIONE ! Le operazioni di fissaggio e collegamento devono essere eseguite solo e obbligatoriamente da personale qualificato!**

  **ATTENZIONE ! Assicurarsi che l'alimentazione sia spenta prima di collegare o scollegare i dispositivi!**



La possibilità di riutilizzare alcune parti elettriche del dispositivo è subordinata alla totale responsabilità dell'utilizzatore. Nell'etichetta è stato riportato il simbolo indicato nel D.lgs n.49 del 14 Marzo 2014 che recepisce la direttiva 2012/19/UE, il quale indica la necessità di smaltire il prodotto nei rifiuti differenziati, nello specifico nei rifiuti di tipo elettrico ed elettronico. Fare riferimento al centro di raccolta rifiuti situato nella Vostra zona.



Alimentatore sostituibile da un professionista



Sorgente luminosa (solo LED) sostituibile da un professionista

Connection - Connessioni

“C” Cable Type (Hybrid cable + connectors)

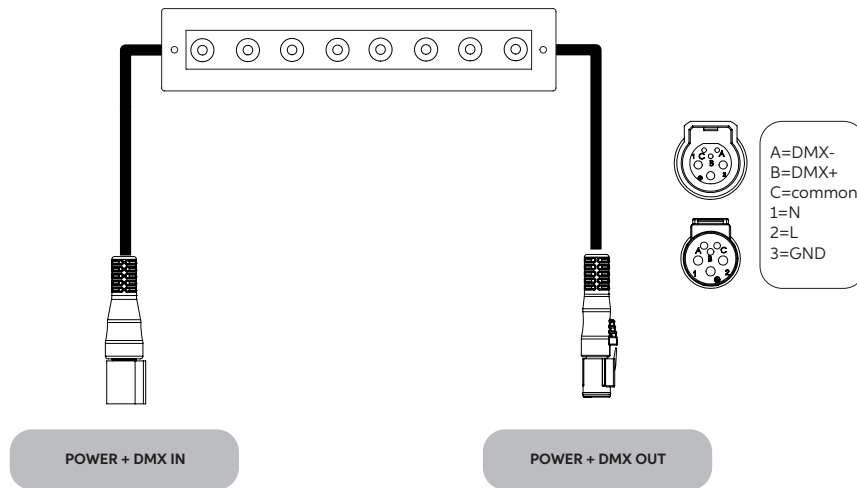

“M” Cable Type (Hybrid cable without connectors)

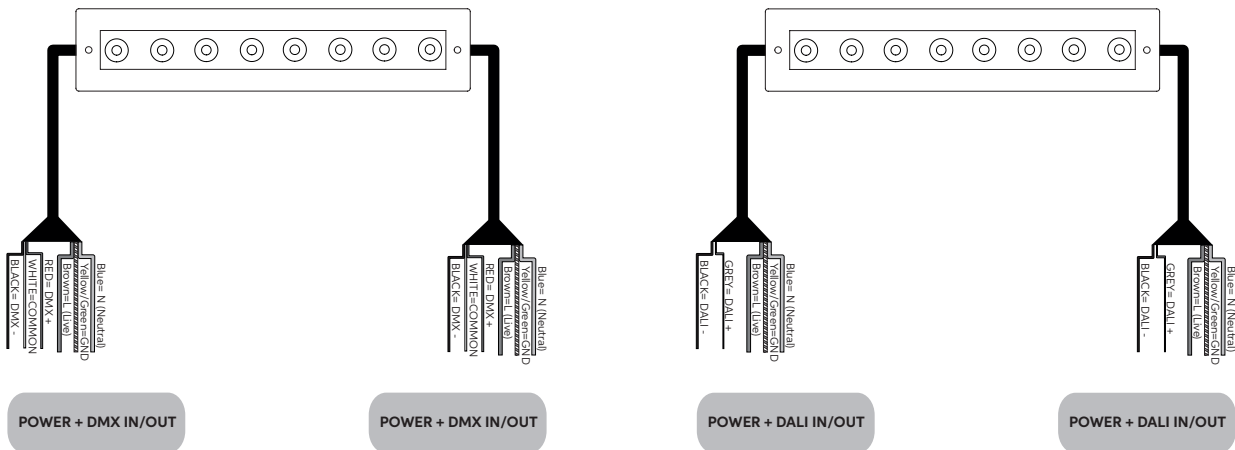

“M” Cable Type (Hybrid cable without connectors - Self-Addressing version)

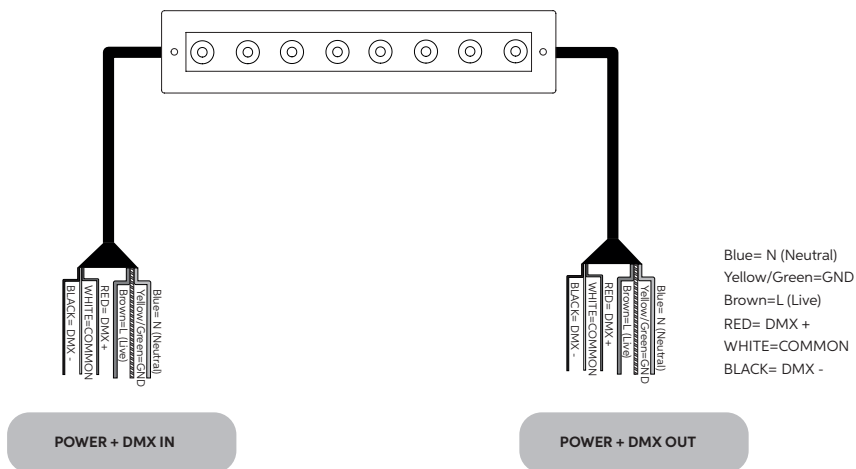

ATTENZIONE - WARNING

ITA: I collegamenti dei cavi di tipo “M” devono essere effettuati utilizzando il kit di collegamento opzionale. Seguire le istruzioni fornite insieme al kit di connessione.

ENG: the connections of “M” cable types must be carried out by using the optional connection kit. Follow the instructions provided along with the connection kit.

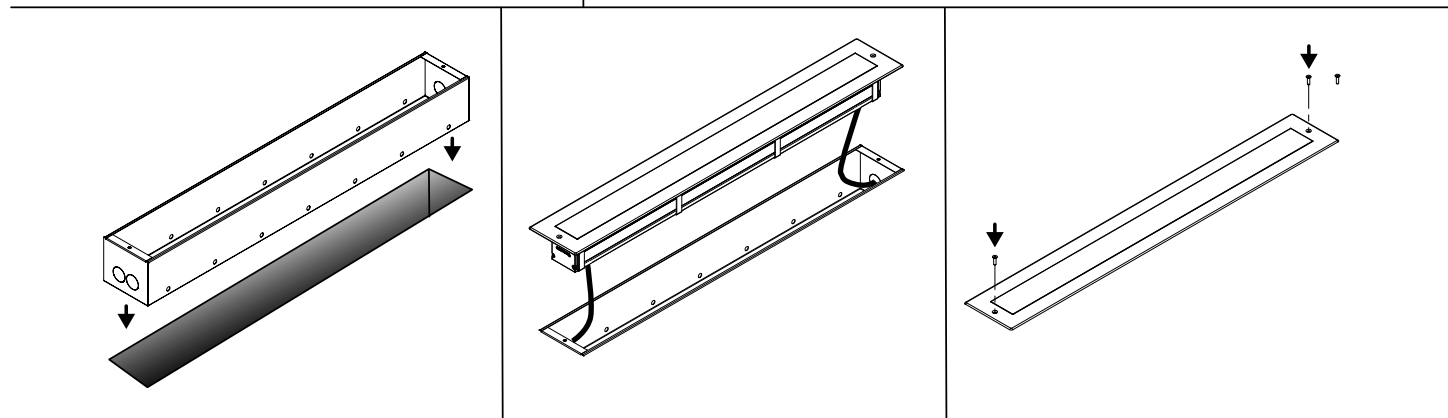
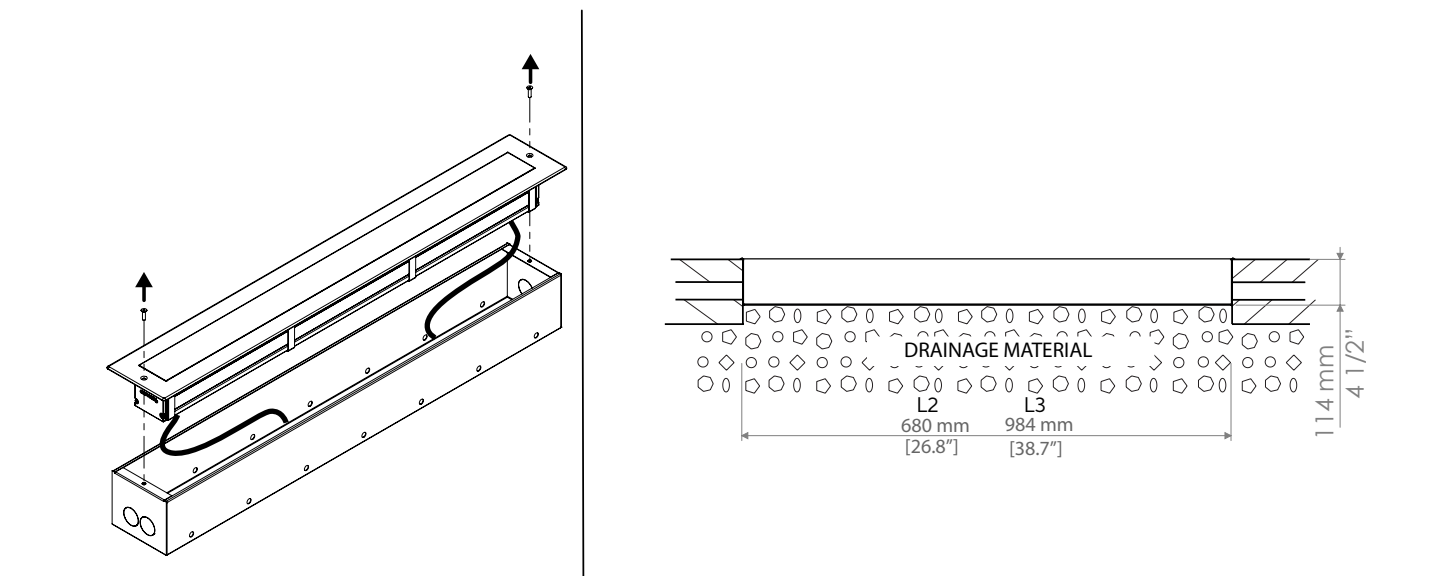

Polar features (only on Polar Edition fixtures)
Caratteristiche Polar (solo su dispositivi Polar Edition)

The POLAR Edition is fitted with a frontal thermal glass which is particularly useful for outdoor applications. In fact, by warming up, the glass melts ice and snow which might interfere with the projection. When the projector is on, if required by the weather conditions, the glass automatically warms up.

La POLAR Edition è dotata di un vetro termico frontale particolarmente utile per applicazioni outdoor. Infatti, riscaldandosi, il vetro scioglie il ghiaccio e la neve che potrebbero interferire con la proiezione. Quando il proiettore è acceso, se richiesto dalle condizioni meteorologiche, il vetro si riscalda automaticamente.

! WARNING: If the projection is to be started at a definite time, deice the glass in advance, so that when the LEDs are switched on at the definite time the glass will be clean.

! ATTENZIONE: Se la proiezione deve essere avviata ad una determinata ora, sghiacciare in anticipo il vetro, in modo che quando i LED vengono accesi all'ora stabilita, il vetro sia pulito.

! WARNING: At very low temperatures (below -20° C), it is mandatory to leave the fixture always powered and to switch on the LEDs when needed.

! ATTENZIONE: A temperature molto basse (inferiori a -20 ° C), è obbligatorio lasciare sempre l'apparecchio alimentato e accendere i led quando necessario.

IR Remote Control operations / Operazioni del telecomando IR

The fixture must be configured only by using AL1321 IR remote control (sold separately) or via any DMX-RDM compatible controller.

L'apparecchiatura deve essere configurata solo utilizzando il telecomando IR AL1321 (venduto separatamente) o tramite qualsiasi controller compatibile DMX-RDM.

LOGIN		1 2 3	5' inactivity = Automatic LOGOUT	= OK		
DMX MODE	DMX MODE SETTING		Enter the corresponding "IR" value (see DMX chart, Mode column) to select the desired DMX mode (e.g. : for Mode #1, IR=4, press button 4).	= OK		
	DMX ADDRESS SETTING		001~512	= OK		
MASTER/SLAVE AUTOMATIC MODE ¹ TO BE USED ONLY WITH DMX MODE #1	AUTOMATIC/MASTER		Green-Cyan-Blue-Magenta-Red-Yellow-White.		5" → 10" → 20" → 40" ² ³ ⁴	
					40" → 20" → 10" → 5" ⁴ ³ ²	
SLAVE FIXTURE SETTING		001		= OK		
FIXED COLOR MODE (RGB-RGBW-DW) TO BE USED ONLY WITH DMX MODE #1			RGB 1 = RED 2 = GREEN 3 = BLUE DW 4 = COLD WHITE 5 = WARM WHITE	RGBW 1 = RED 2 = GREEN 3 = BLUE 4 = WHITE		0% → 100%
DIMMER MODE (Monochromatic) TO BE USED ONLY WITH DMX MODE #1					100% → 0% 	
LOGOUT			1			
RESET			7 8 9	Reset to default settings		
WIRELESS			1 = Unlink 2 = Wireless LED status ON 3 = Wireless LED status OFF			

¹ WARNING ! in this mode, no other DMX control device must be present along the line.

² Only on wireless fixtures

¹ ATTENZIONE ! in questa modalità non deve essere presente lungo la linea nessun altro dispositivo di controllo DMX.

² Solo su dispositivi wireless

DMX Chart

RGBW

Mode	Channel	Function	Value
#1 IR=4	1	0-100% Red	0-255
	2	0-100% Green	0-255
	3	0-100% Blue	0-255
	4	0-100% White	0-255
#2 IR=5	1	0-100% Red	0-255
	2	0-100% Green	0-255
	3	0-100% Blue	0-255
	4	0-100% White	0-255
	5	0→100% Dimmer	0-255
#3 IR=6	1	0-100% Red	0-255
	2	0-100% Green	0-255
	3	0-100% Blue	0-255
	4	0-100% White	0-255
	5	0% Dimmer	0-5
		100-0% Dimmer	6-250
		100% Dimmer	251-255
	6	No Strobe	0-5
		0-100% Strobe	6-250
		100% Strobe	251-255
#4 IR=7	1	0-100% Red	0-255
	2	0-100% Green	0-255
	3	0-100% Blue	0-255
	4	0-100% White	0-255
	5	NO FUNCTION	0-5
		2700K	6-7
		2700K→3000K	8-40
		3000K	41-42
		3000K→3500K	43-75
		3500K	76-77
		3500K→4000K	78-110
		4000K	111-112
		4000K→4500K	113-145
		4500K	146-147
		4500K→5000K	148-179
		5000K	180-181
		5000K→5500K	182-214
		5500K	215-216
	5500K→6000K	217-249	
	6000K	250-255	
	6	0→100% Dimmer	0-255
	#5 IR=8	1	0-100% Red
2		0-100% Red	0-255
3		0-100% Green	0-255
4		0-100% Green	0-255
5		0-100% Blue	0-255
6		0-100% Blue	0-255
7		0-100% White	0-255
8		0-100% White	0-255

Mode	Channel	Function	Value
#6 IR=9 (Default)	1	0-100% Red	0-255
	2	0-100% Green	0-255
	3	0-100% Blue	0-255
	4	0-100% Calibrated White (affects RGB channels)	0-255

Note: in absence of DMX signal the LEDs will remain **OFF**.

Independent pixels

Nelle versioni "Independent pixels" le funzioni citate nelle precedenti tabelle vengono ripetute per il numero di moduli dell'apparecchio. Es. Parade L3 RGBW nella modalità #1 impegna 12 canali. In the "Independent pixels" versions, the functions mentioned in the previous tables are repeated for the number of modules in the device. E.g. Parade L3 RGBW in mode #1 engages 12 channels.

RDM functions

When operating in DMX mode the fixture can accept the following RDM commands:

- Discovery: upon request of the RDM controller, the fixture signal its own presence (the RDM controller will display the fixture on a list).
- DMX address reading and setting.
- Channels number reading and setting.
- On / Off identification: this command is used to identify the fixture you want to get access to (the identification happens by switching on all the LEDs at full intensity).
- Manufacturer: it displays the name of the manufacturer (Griven).
- Model description: it displays the fixture's model.
- Software version description: it displays the current version of the firmware.
- Temperature: it displays the LEDs operating temperature value.

Command #	Description
1	Off
2	Up (Fade rate)
3	Down (Fade rate)
4	Step Up (Increment arc power level)
5	Step Down (Decrement arc power level)
6	Recall MAX level
7	Recall MIN level
8	Step down and off (Decrement arc power level if at min level turn down)
16...31	Go to scene 0...15
32	Reset (DALI factory default parameters)
33	Store actual level in the DTR
42	Store DTR as MAX level
43	Store DTR as MIN level
45	Store DTR as Power On level
46	Store DTR as Fade Time
47	Store DTR as Fade Rate
64-79	Store DTR as Scene 0...15
80-95	Remove from Scene 0...15
96...111	Add to Group 0...15
112...127	Remove from Group 0...15
128	Store DTR as Short Address
144	Query Status
145	Query Ballast
151	Query Version Number
152	Query Content DTR
153	Query Device Type
154	Query Physical Minimum Level
155	Query Power Failure
160	Query Actual Level
161	Query Max level
162	Query Min level
163	Query Power On level
164	Query System Failure level
165	Query Fade Time/Fade Rate
176...191	Query Scene level
192	Query Groups 0...7
193	Query Groups 8...15
194	Query Random Address High
195	Query Random Address Middle
196	Query Random Address Low

Configuration examples

Single Chain Configuration

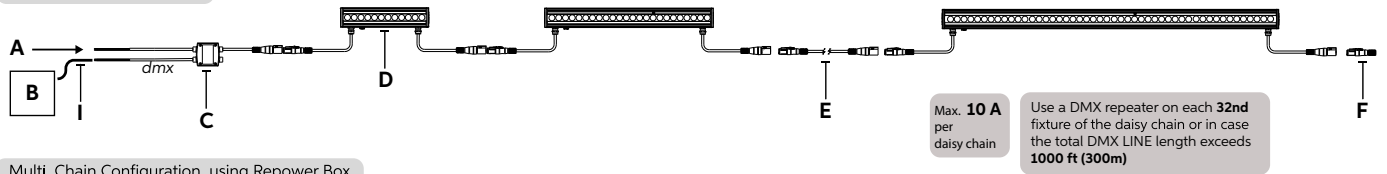

Multi Chain Configuration using Repower Box

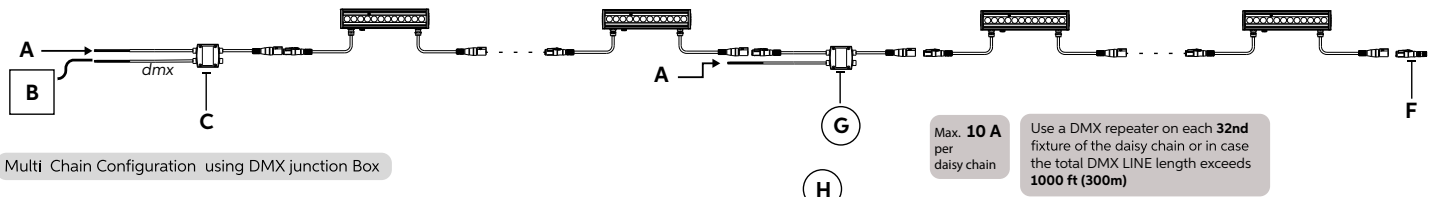

Multi Chain Configuration using DMX junction Box

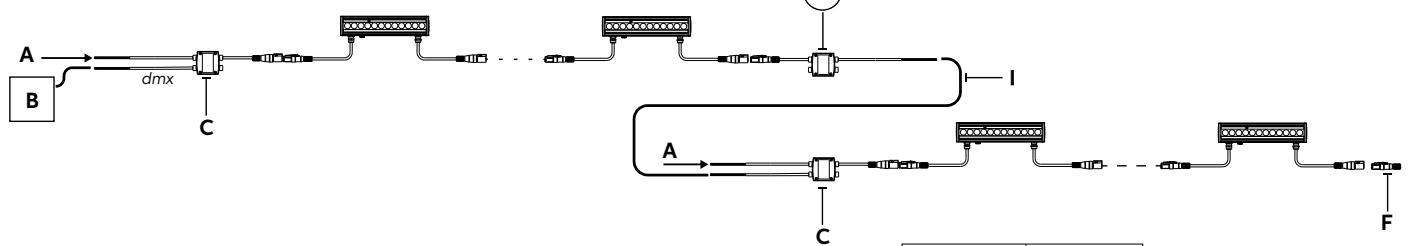

- A - Power Input
- B - DMX/RDM Controller
- C - Start Line Box - AL5058C with connectors / AL5058M without connectors
- D - Parade L-1, L-2, L-3, L-4, L-2 Recessed, L-3 Recessed
- E - Connection Cable - AL8264 L=1m AL8265 L=2m AL8266 L=3m AL8267 L=5m AL8268 L=10m
- F - DMX Terminator - AL5169
- G - Repower Box - AL5167C with connectos / AL5167M without connectors
- H - DMX Junction Box - AL5059C with connectors / AL5059M without connectors
- I - DMX Cable - AL0512

CE Colours	USE
Brown	Live
Blue	Neutral
Yellow/Green	Ground
Red	DMX Data +
Black	DMX Data -
White	DMX GND

Operating modes

DMX Mode

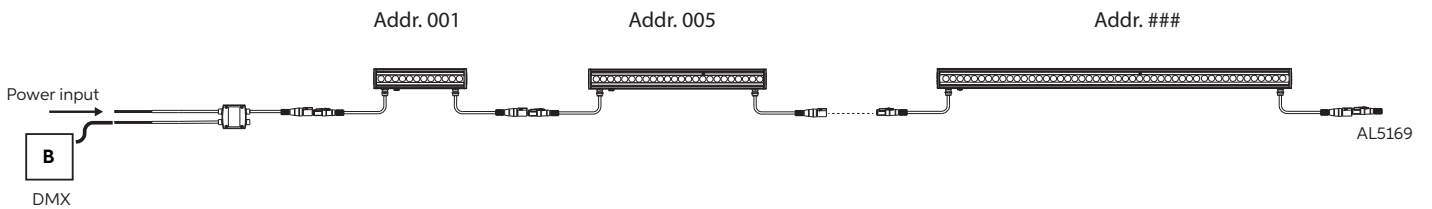

Example with fixtures set at 4 DMX channels

Master-Slave / Automatic / Fixed color Mode

(Only DMX Mode #1)

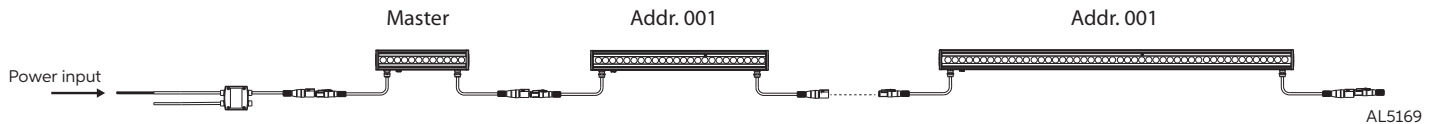

WARNING ! in this mode, no other DMX control device must be present along the line.